

# DMX512

## Dimmable Constant Current LED Driver

Indoor lighting Driver Series > Multi-Current output DIP adjustment & NFC

DT6 Dimming | DT8 CCT Dimming



### Wiring diagram

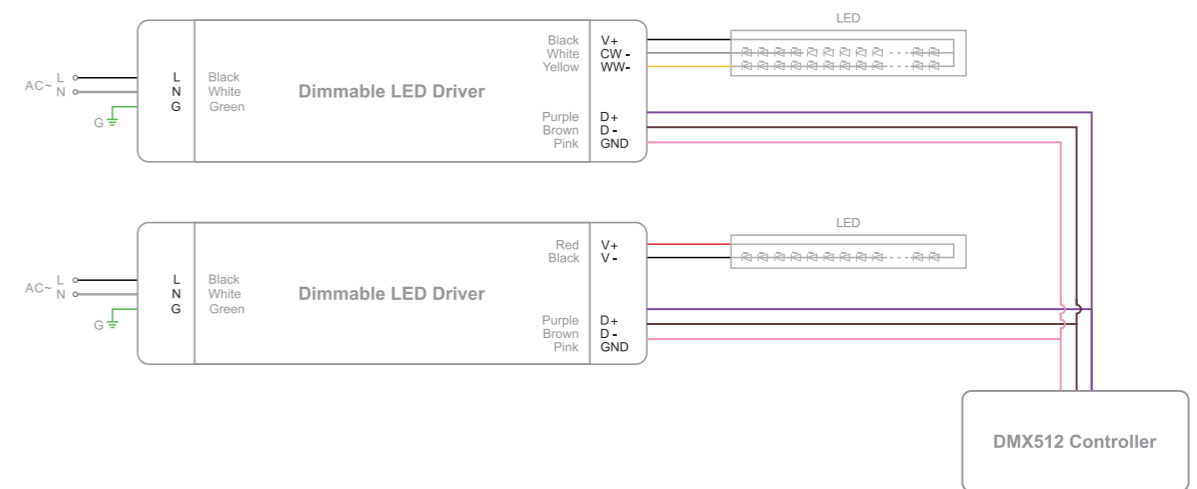

### SMT-M-CX Series ( Multi-Current output )

### SMT-DI-DMX Series ( DMX512 Dimming )



1-2 CH  
Dimming | CCT



1 - 100%  
Full dimming range



Flicker-free  
Smooth dimming



NFC function  
Setting address



RDM function  
Setting address



DIP  
Adjustment Current

#### Perfect for LED fixtures

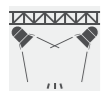

Stage lights

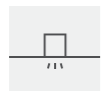

Spotlights



Downlights



Spotlights

# DMX512 Series

## 100-277VAC Constant Current Dimmable LED Driver



### DMX512 Series

#### DMX512 Dimming

SMT-M-CX \* series

SMT-DI-DMX \* series

- SMT-DI-DMX series : With 12V/0.3A Built-in Auxiliary power, Ultra-high PF value and low THD

- The KIX series based on DMX 512 protocol , should be provided with RDM / NFC function.

Constant current 10-60W with 1-2 channels

- Input 100-277VAC

- Dimming depth 1%

- Ultra-high PF value and low THD

- ProNFC APP & Handheld device function:

1. Setting address
2. Setting current
3. Temperature control ( SMT-DI-DMX series )
4. Setting light decay compensation ( SMT-DI-DMX series )
5. Timing ( SMT-DI-DMX series )
6. Setting life warning ( SMT-DI-DMX series )

- Handheld device Function

- Setting address

- RDM Function

- Setting address



#### ProNFC APP Download



**SMT-DI020W070-DMXP**

- 1 Slim Size
- 2 Power: 20W / 40W / 60W / 100W
- 3 Max. output current
- 4 DMX : DMX512 Dimming
- 5 P: IP20 Screw-free Linear plastic driver  
A: IP66 Linear aluminum driver  
I: IP20 Linear Iron driver



**SMT-M-010CX-1C-P**

- 1 Multi-Current output
- 2 Power: 10W / 20W / 40W / 60W
- 3 CX: DMX512 Dimming
- 4 1C: 1CH Dimming  
2C: 2CH CCT
- 5 P: IP20 Plastic driver

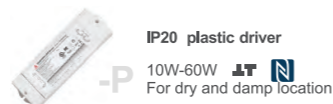

**SMT-M-1C-010CXJ**

- 1 Multi-Current output
- 2 1C: 1CH Dimming  
2C: 2CH CCT
- 3 Power: 10W / 20W / 40W / 60W
- 4 CX: DMX512 Dimming
- 5 J: Aluminum Built-in Junction box driver

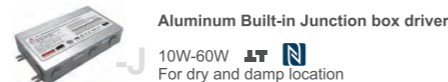











DT Dip adjustment current N NFC setting address

| Power             | Picture | Model              | Output           | Input     | Size          | Channels | Address Setting | Location | Others          |  |                    |                 |           |                 |     |     |              |                 |
|-------------------|---------|--------------------|------------------|-----------|---------------|----------|-----------------|----------|-----------------|--|--------------------|-----------------|-----------|-----------------|-----|-----|--------------|-----------------|
| 10W               |         | SMT-M-010CX-1C-P   | 3-42V 100mA TTTT | 100-277AC | 135*30*20mm   | 1CH      | RDM / NFC       | Dry Damp | Class 2 Class P |  |                    |                 |           |                 |     |     |              |                 |
|                   |         |                    | 3-42V 150mA TTTT |           |               |          |                 |          |                 |  |                    |                 |           |                 |     |     |              |                 |
|                   |         |                    | 3-42V 200mA TTTT |           |               |          |                 |          |                 |  |                    |                 |           |                 |     |     |              |                 |
|                   |         |                    | 3-40V 250mA TTTT |           |               |          |                 |          |                 |  |                    |                 |           |                 |     |     |              |                 |
|                   |         |                    | 3-33V 300mA TTTT |           |               |          |                 |          |                 |  |                    |                 |           |                 |     |     |              |                 |
|                   |         |                    | 3-29V 350mA TTTT |           |               |          |                 |          |                 |  |                    |                 |           |                 |     |     |              |                 |
|                   |         |                    | 3-25V 400mA TTTT |           |               |          |                 |          |                 |  |                    |                 |           |                 |     |     |              |                 |
| 3-22V 450mA TTTT  |         |                    |                  |           |               |          |                 |          |                 |  |                    |                 |           |                 |     |     |              |                 |
| 10W               |         | SMT-M-1C-010CXJ    | 3-42V 100mA TTTT | 100-277AC | 163*94*36mm   | 1CH      | RDM / NFC       | Dry Damp | Class 2 Class P |  |                    |                 |           |                 |     |     |              |                 |
|                   |         |                    | 3-42V 150mA TTTT |           |               |          |                 |          |                 |  |                    |                 |           |                 |     |     |              |                 |
|                   |         |                    | 3-42V 200mA TTTT |           |               |          |                 |          |                 |  |                    |                 |           |                 |     |     |              |                 |
|                   |         |                    | 3-40V 250mA TTTT |           |               |          |                 |          |                 |  |                    |                 |           |                 |     |     |              |                 |
|                   |         |                    | 3-33V 300mA TTTT |           |               |          |                 |          |                 |  |                    |                 |           |                 |     |     |              |                 |
|                   |         |                    | 3-29V 350mA TTTT |           |               |          |                 |          |                 |  |                    |                 |           |                 |     |     |              |                 |
|                   |         |                    | 3-25V 400mA TTTT |           |               |          |                 |          |                 |  |                    |                 |           |                 |     |     |              |                 |
| 3-22V 450mA TTTT  |         |                    |                  |           |               |          |                 |          |                 |  |                    |                 |           |                 |     |     |              |                 |
| 10W               |         | SMT-M-020CX-xC-P   | 3-42V 250mA TTTT | 100-277AC | 159.5*43*20mm | 1-2CH    | RDM / NFC       | Dry Damp | Class 2 Class P |  |                    |                 |           |                 |     |     |              |                 |
|                   |         |                    | 3-42V 350mA TTTT |           |               |          |                 |          |                 |  |                    |                 |           |                 |     |     |              |                 |
|                   |         |                    | 3-42V 400mA TTTT |           |               |          |                 |          |                 |  |                    |                 |           |                 |     |     |              |                 |
|                   |         |                    | 3-42V 450mA TTTT |           |               |          |                 |          |                 |  |                    |                 |           |                 |     |     |              |                 |
|                   |         |                    | 3-40V 500mA TTTT |           |               |          |                 |          |                 |  |                    |                 |           |                 |     |     |              |                 |
|                   |         |                    | 3-36V 550mA TTTT |           |               |          |                 |          |                 |  |                    |                 |           |                 |     |     |              |                 |
|                   |         |                    | 3-33V 600mA TTTT |           |               |          |                 |          |                 |  |                    |                 |           |                 |     |     |              |                 |
| 3-29V 700mA TTTT  |         |                    |                  |           |               |          |                 |          |                 |  |                    |                 |           |                 |     |     |              |                 |
| 20W               |         | SMT-DI020W070-DMXP | 12-54V 70-700mA  | 100-277AC | 252*31*22.5mm | 1CH      | NFC             | Dry Damp | Class P         |  |                    |                 |           |                 |     |     |              |                 |
|                   |         |                    | 20W              |           |               |          |                 |          |                 |  | SMT-DI020W070-DMXA | 12-54V 70-700mA | 100-277AC | 238*38.5*23.6mm | 1CH | NFC | Wet Dry Damp | Class P TYPE HL |
|                   |         |                    |                  |           |               |          |                 |          |                 |  |                    | 20W             |           |                 |     |     |              |                 |
| 10W               |         | SMT-M-xC-020CXJ    | 3-42V 250mA TTTT | 100-277AC | 163*94*36mm   | 1-2CH    | RDM / NFC       | Dry Damp | Class 2 Class P |  |                    |                 |           |                 |     |     |              |                 |
|                   |         |                    | 3-42V 350mA TTTT |           |               |          |                 |          |                 |  |                    |                 |           |                 |     |     |              |                 |
|                   |         |                    | 3-42V 400mA TTTT |           |               |          |                 |          |                 |  |                    |                 |           |                 |     |     |              |                 |
|                   |         |                    | 3-42V 450mA TTTT |           |               |          |                 |          |                 |  |                    |                 |           |                 |     |     |              |                 |
|                   |         |                    | 3-40V 500mA TTTT |           |               |          |                 |          |                 |  |                    |                 |           |                 |     |     |              |                 |
|                   |         |                    | 3-36V 550mA TTTT |           |               |          |                 |          |                 |  |                    |                 |           |                 |     |     |              |                 |
|                   |         |                    | 3-33V 600mA TTTT |           |               |          |                 |          |                 |  |                    |                 |           |                 |     |     |              |                 |
| 3-29V 700mA TTTT  |         |                    |                  |           |               |          |                 |          |                 |  |                    |                 |           |                 |     |     |              |                 |
| 10W               |         | SMT-M-040CX-1C-P   | 3-50V 300mA TTTT | 100-277AC | 171.5*54*20mm | 1CH      | DALI System     | Dry Damp | Class P         |  |                    |                 |           |                 |     |     |              |                 |
|                   |         |                    | 3-50V 350mA TTTT |           |               |          |                 |          |                 |  |                    |                 |           |                 |     |     |              |                 |
|                   |         |                    | 3-50V 400mA TTTT |           |               |          |                 |          |                 |  |                    |                 |           |                 |     |     |              |                 |
|                   |         |                    | 3-50V 450mA TTTT |           |               |          |                 |          |                 |  |                    |                 |           |                 |     |     |              |                 |
|                   |         |                    | 3-50V 500mA TTTT |           |               |          |                 |          |                 |  |                    |                 |           |                 |     |     |              |                 |
|                   |         |                    | 3-50V 550mA TTTT |           |               |          |                 |          |                 |  |                    |                 |           |                 |     |     |              |                 |
|                   |         |                    | 3-50V 600mA TTTT |           |               |          |                 |          |                 |  |                    |                 |           |                 |     |     |              |                 |
|                   |         |                    | 3-50V 650mA TTTT |           |               |          |                 |          |                 |  |                    |                 |           |                 |     |     |              |                 |
|                   |         |                    | 3-50V 700mA TTTT |           |               |          |                 |          |                 |  |                    |                 |           |                 |     |     |              |                 |
|                   |         |                    | 3-50V 800mA TTTT |           |               |          |                 |          |                 |  |                    |                 |           |                 |     |     |              |                 |
| 3-45V 900mA TTTT  |         |                    |                  |           |               |          |                 |          |                 |  |                    |                 |           |                 |     |     |              |                 |
| 3-40V 1000mA TTTT |         |                    |                  |           |               |          |                 |          |                 |  |                    |                 |           |                 |     |     |              |                 |
| 3-37V 1100mA TTTT |         |                    |                  |           |               |          |                 |          |                 |  |                    |                 |           |                 |     |     |              |                 |
| 3-34V 1200mA TTTT |         |                    |                  |           |               |          |                 |          |                 |  |                    |                 |           |                 |     |     |              |                 |
| 3-31V 1300mA TTTT |         |                    |                  |           |               |          |                 |          |                 |  |                    |                 |           |                 |     |     |              |                 |
| 3-29V 1400mA TTTT |         |                    |                  |           |               |          |                 |          |                 |  |                    |                 |           |                 |     |     |              |                 |

DMX512

DMX512

| Power         | Picture   | Model              | Output            | Input | Size      | Channels          | Address Setting | Location    | Others   |                    |
|---------------|---|--------------------|-------------------|-------|-----------|-------------------|-----------------|-------------|----------|--------------------|
| 40W           |    | SMT-M-C040CX-1C-P  | 3-50V 300mA       | ▬▬▬▬  | 100-277AC | 171.5*54*20mm     | 1CH             | DALI System | Dry Damp | Class 2<br>Class P |
|               |   |                    | 3-50V 350mA       | ▬▬▬▬  |           |                   |                 |             |          |                    |
|               |   |                    | 3-50V 400mA       | ▬▬▬▬  |           |                   |                 |             |          |                    |
|               |   |                    | 3-50V 450mA       | ▬▬▬▬  |           |                   |                 |             |          |                    |
|               |   |                    | 3-50V 500mA       | ▬▬▬▬  |           |                   |                 |             |          |                    |
|               |   |                    | 3-50V 550mA       | ▬▬▬▬  |           |                   |                 |             |          |                    |
|               |   |                    | 3-50V 600mA       | ▬▬▬▬  |           |                   |                 |             |          |                    |
|               |   |                    | 3-50V 650mA       | ▬▬▬▬  |           |                   |                 |             |          |                    |
|               |   |                    | 3-50V 700mA       | ▬▬▬▬  |           |                   |                 |             |          |                    |
|               |   |                    | 3-50V 800mA       | ▬▬▬▬  |           |                   |                 |             |          |                    |
|               |   |                    | 3-45V 900mA       | ▬▬▬▬  |           |                   |                 |             |          |                    |
|               |   |                    | 3-40V 1000mA      | ▬▬▬▬  |           |                   |                 |             |          |                    |
|               |   |                    | 3-37V 1100mA      | ▬▬▬▬  |           |                   |                 |             |          |                    |
|               |   |                    | 3-34V 1200mA      | ▬▬▬▬  |           |                   |                 |             |          |                    |
| 3-31V 1300mA  | ▬▬▬▬  |                    |                   |       |           |                   |                 |             |          |                    |
| 3-29V 1400mA  | ▬▬▬▬  |                    |                   |       |           |                   |                 |             |          |                    |
|               |    | SMT-M-040CX-2C-P   | 3-42V 250mA*2     | ▬▬▬▬  | 100-277AC | 171.5*54*20mm     | 2CH             | RDM / NFC   | Dry Damp | Class P            |
|               |   |                    | 3-42V 350mA*2     | ▬▬▬▬  |           |                   |                 |             |          |                    |
|               |   |                    | 3-42V 400mA*2     | ▬▬▬▬  |           |                   |                 |             |          |                    |
|               |   |                    | 3-42V 450mA*2     | ▬▬▬▬  |           |                   |                 |             |          |                    |
|               |   |                    | 3-40V 500mA*2     | ▬▬▬▬  |           |                   |                 |             |          |                    |
|               |   |                    | 3-36V 550mA*2     | ▬▬▬▬  |           |                   |                 |             |          |                    |
|               |   |                    | 3-33V 600mA*2     | ▬▬▬▬  |           |                   |                 |             |          |                    |
| 3-29V 700mA*2 | ▬▬▬▬  |                    |                   |       |           |                   |                 |             |          |                    |
|               |   | SMT-M-C040CX-2C-P  | 3-42V 250mA*2     | ▬▬▬▬  | 100-277AC | 171.5*54*20mm     | 2CH             | RDM / NFC   | Dry Damp | Class 2<br>Class P |
|               |   |                    | 3-42V 350mA*2     | ▬▬▬▬  |           |                   |                 |             |          |                    |
|               |   |                    | 3-42V 400mA*2     | ▬▬▬▬  |           |                   |                 |             |          |                    |
|               |   |                    | 3-42V 450mA*2     | ▬▬▬▬  |           |                   |                 |             |          |                    |
|               |   |                    | 3-40V 500mA*2     | ▬▬▬▬  |           |                   |                 |             |          |                    |
|               |   |                    | 3-36V 550mA*2     | ▬▬▬▬  |           |                   |                 |             |          |                    |
|               |   |                    | 3-33V 600mA*2     | ▬▬▬▬  |           |                   |                 |             |          |                    |
| 3-29V 700mA*2 | ▬▬▬▬  |                    |                   |       |           |                   |                 |             |          |                    |
| 40W           |  | SMT-DI040W140-DMXP | 12-54V 140-1400mA | ▬▬▬▬  | 100-277AC | 314.7*38.5*23.6mm | 1CH             | NFC         | Dry Damp | Class P            |
|               |   | SMT-DI040W070-DMXP | 24-93V 70-700mA   | ▬▬▬▬  |           |                   |                 |             |          |                    |
|               |   | SMT-DI040W140-DMXA | 12-54V 140-1400mA | ▬▬▬▬  |           |                   |                 |             |          |                    |
|               |   | SMT-DI040W070-DMXA | 24-93V 70-700mA   | ▬▬▬▬  |           |                   |                 |             |          |                    |
|               |   | SMT-DI040W140-DMXI | 12-54V 140-1400mA | ▬▬▬▬  |           |                   |                 |             |          |                    |
|               |   | SMT-DI040W070-DMXI | 24-93V 70-700mA   | ▬▬▬▬  |           |                   |                 |             |          |                    |
|               |  | SMT-M-1C-040CXJ    | 3-50V 300mA       | ▬▬▬▬  | 100-277AC | 190*104*36mm      | 1CH             | DALI System | Dry Damp | Class P            |
|               |   |                    | 3-50V 350mA       | ▬▬▬▬  |           |                   |                 |             |          |                    |
|               |   |                    | 3-50V 400mA       | ▬▬▬▬  |           |                   |                 |             |          |                    |
|               |   |                    | 3-50V 450mA       | ▬▬▬▬  |           |                   |                 |             |          |                    |
|               |   |                    | 3-50V 500mA       | ▬▬▬▬  |           |                   |                 |             |          |                    |
|               |   |                    | 3-50V 550mA       | ▬▬▬▬  |           |                   |                 |             |          |                    |
|               |   |                    | 3-50V 600mA       | ▬▬▬▬  |           |                   |                 |             |          |                    |
|               |   |                    | 3-50V 650mA       | ▬▬▬▬  |           |                   |                 |             |          |                    |
|               |   |                    | 3-50V 700mA       | ▬▬▬▬  |           |                   |                 |             |          |                    |
|               |   |                    | 3-50V 800mA       | ▬▬▬▬  |           |                   |                 |             |          |                    |
|               |   |                    | 3-45V 900mA       | ▬▬▬▬  |           |                   |                 |             |          |                    |
|               |   |                    | 3-40V 1000mA      | ▬▬▬▬  |           |                   |                 |             |          |                    |
|               |   |                    | 3-37V 1100mA      | ▬▬▬▬  |           |                   |                 |             |          |                    |
|               |   |                    | 3-34V 1200mA      | ▬▬▬▬  |           |                   |                 |             |          |                    |
| 3-31V 1300mA  | ▬▬▬▬  |                    |                   |       |           |                   |                 |             |          |                    |
| 3-29V 1400mA  | ▬▬▬▬  |                    |                   |       |           |                   |                 |             |          |                    |

| Power         | Picture   | Model             | Output        | Input | Size      | Channels      | Address Setting | Location    | Others   |                    |
|---------------|---|-------------------|---------------|-------|-----------|---------------|-----------------|-------------|----------|--------------------|
| 40W           |    | SMT-M-1C-C040CXJ  | 3-50V 300mA   | ▬▬▬▬  | 100-277AC | 190*104*36mm  | 1CH             | DALI System | Dry Damp | Class 2<br>Class P |
|               |   |                   | 3-50V 350mA   | ▬▬▬▬  |           |               |                 |             |          |                    |
|               |   |                   | 3-50V 400mA   | ▬▬▬▬  |           |               |                 |             |          |                    |
|               |   |                   | 3-50V 450mA   | ▬▬▬▬  |           |               |                 |             |          |                    |
|               |   |                   | 3-50V 500mA   | ▬▬▬▬  |           |               |                 |             |          |                    |
|               |   |                   | 3-50V 550mA   | ▬▬▬▬  |           |               |                 |             |          |                    |
|               |   |                   | 3-50V 600mA   | ▬▬▬▬  |           |               |                 |             |          |                    |
|               |   |                   | 3-50V 650mA   | ▬▬▬▬  |           |               |                 |             |          |                    |
|               |   |                   | 3-50V 700mA   | ▬▬▬▬  |           |               |                 |             |          |                    |
|               |   |                   | 3-50V 800mA   | ▬▬▬▬  |           |               |                 |             |          |                    |
|               |   |                   | 3-45V 900mA   | ▬▬▬▬  |           |               |                 |             |          |                    |
|               |   |                   | 3-40V 1000mA  | ▬▬▬▬  |           |               |                 |             |          |                    |
|               |   |                   | 3-37V 1100mA  | ▬▬▬▬  |           |               |                 |             |          |                    |
|               |   |                   | 3-34V 1200mA  | ▬▬▬▬  |           |               |                 |             |          |                    |
| 3-31V 1300mA  | ▬▬▬▬  |                   |               |       |           |               |                 |             |          |                    |
| 3-29V 1400mA  | ▬▬▬▬  |                   |               |       |           |               |                 |             |          |                    |
| 40W           |    | SMT-M-2C-040CXJ   | 3-42V 250mA*2 | ▬▬▬▬  | 100-277AC | 190*104*36mm  | 2CH             | RDM / NFC   | Dry Damp | Class P            |
|               |   |                   | 3-42V 350mA*2 | ▬▬▬▬  |           |               |                 |             |          |                    |
|               |   |                   | 3-42V 400mA*2 | ▬▬▬▬  |           |               |                 |             |          |                    |
|               |   |                   | 3-42V 450mA*2 | ▬▬▬▬  |           |               |                 |             |          |                    |
|               |   |                   | 3-40V 500mA*2 | ▬▬▬▬  |           |               |                 |             |          |                    |
|               |   |                   | 3-36V 550mA*2 | ▬▬▬▬  |           |               |                 |             |          |                    |
|               |   |                   | 3-33V 600mA*2 | ▬▬▬▬  |           |               |                 |             |          |                    |
| 3-29V 700mA*2 | ▬▬▬▬  |                   |               |       |           |               |                 |             |          |                    |
| 40W           |    | SMT-M-2C-C040CXJ  | 3-42V 250mA*2 | ▬▬▬▬  | 100-277AC | 190*104*36mm  | 2CH             | RDM / NFC   | Dry Damp | Class 2<br>Class P |
|               |   |                   | 3-42V 350mA*2 | ▬▬▬▬  |           |               |                 |             |          |                    |
|               |   |                   | 3-42V 400mA*2 | ▬▬▬▬  |           |               |                 |             |          |                    |
|               |   |                   | 3-42V 450mA*2 | ▬▬▬▬  |           |               |                 |             |          |                    |
|               |   |                   | 3-40V 500mA*2 | ▬▬▬▬  |           |               |                 |             |          |                    |
|               |   |                   | 3-36V 550mA*2 | ▬▬▬▬  |           |               |                 |             |          |                    |
|               |   |                   | 3-33V 600mA*2 | ▬▬▬▬  |           |               |                 |             |          |                    |
| 3-29V 700mA*2 | ▬▬▬▬  |                   |               |       |           |               |                 |             |          |                    |
| 40W           |  | SMT-M-060CX-xC-P  | 3-65V 600mA   | ▬▬▬▬  | 100-277AC | 192.5*62*24mm | 1CH             | RDM / NFC   | Dry Damp | Class P            |
|               |   |                   | 3-65V 700mA   | ▬▬▬▬  |           |               |                 |             |          |                    |
|               |   |                   | 3-65V 800mA   | ▬▬▬▬  |           |               |                 |             |          |                    |
|               |   |                   | 3-65V 900mA   | ▬▬▬▬  |           |               |                 |             |          |                    |
|               |   |                   | 3-60V 1000mA  | ▬▬▬▬  |           |               |                 |             |          |                    |
|               |   |                   | 3-54V 1100mA  | ▬▬▬▬  |           |               |                 |             |          |                    |
|               |   |                   | 3-50V 1200mA  | ▬▬▬▬  |           |               |                 |             |          |                    |
|               |   |                   | 3-46V 1300mA  | ▬▬▬▬  |           |               |                 |             |          |                    |
|               |   |                   | 3-43V 1400mA  | ▬▬▬▬  |           |               |                 |             |          |                    |
|               |   |                   | 3-40V 1500mA  | ▬▬▬▬  |           |               |                 |             |          |                    |
|               |   |                   | 3-38V 1600mA  | ▬▬▬▬  |           |               |                 |             |          |                    |
|               |   |                   | 3-35V 1700mA  | ▬▬▬▬  |           |               |                 |             |          |                    |
|               |   |                   | 3-33V 1800mA  | ▬▬▬▬  |           |               |                 |             |          |                    |
|               |   |                   | 3-32V 1900mA  | ▬▬▬▬  |           |               |                 |             |          |                    |
| 3-30V 2000mA  | ▬▬▬▬  |                   |               |       |           |               |                 |             |          |                    |
| 3-29V 2100mA  | ▬▬▬▬  |                   |               |       |           |               |                 |             |          |                    |
| 60W           |  | SMT-M-C060CX-xC-P | 3-50V 600mA   | ▬▬▬▬  | 100-277AC | 192.5*62*24mm | 1CH             | RDM / NFC   | Dry Damp | Class 2<br>Class P |
|               |   |                   | 3-50V 700mA   | ▬▬▬▬  |           |               |                 |             |          |                    |
|               |   |                   | 3-50V 800mA   | ▬▬▬▬  |           |               |                 |             |          |                    |
|               |   |                   | 3-50V 900mA   | ▬▬▬▬  |           |               |                 |             |          |                    |
|               |   |                   | 3-50V 1000mA  | ▬▬▬▬  |           |               |                 |             |          |                    |
|               |   |                   | 3-50V 1100mA  | ▬▬▬▬  |           |               |                 |             |          |                    |
|               |   |                   | 3-50V 1200mA  | ▬▬▬▬  |           |               |                 |             |          |                    |
|               |   |                   | 3-46V 1300mA  | ▬▬▬▬  |           |               |                 |             |          |                    |
|               |   |                   | 3-43V 1400mA  | ▬▬▬▬  |           |               |                 |             |          |                    |
|               |   |                   | 3-40V 1500mA  | ▬▬▬▬  |           |               |                 |             |          |                    |
|               |   |                   | 3-38V 1600mA  | ▬▬▬▬  |           |               |                 |             |          |                    |
|               |   |                   | 3-35V 1700mA  | ▬▬▬▬  |           |               |                 |             |          |                    |
|               |   |                   | 3-33V 1800mA  | ▬▬▬▬  |           |               |                 |             |          |                    |
|               |   |                   | 3-32V 1900mA  | ▬▬▬▬  |           |               |                 |             |          |                    |
| 3-30V 2000mA  | ▬▬▬▬  |                   |               |       |           |               |                 |             |          |                    |
| 3-29V 2100mA  | ▬▬▬▬  |                   |               |       |           |               |                 |             |          |                    |

DMX512

DMX512

## SMT-DI020W070-DMXP

1 2 3 4 5

- 1 Slim Size
- 2 Power: 20W / 40W / 60W / 100W
- 3 Max. output current
- 4 DMX : DMX512 Dimming
- 5 P: IP20 Screw-free Linear plastic driver  
A: IP66 Linear aluminum driver  
I: IP20 Linear Iron driver



## SMT-M-010CX-1C-P

1 2 3 4 5

- 1 Multi-Current output
- 2 Power: 10W / 20W / 40W / 60W
- 3 CX: DMX512 Dimming
- 4 1C: 1CH Dimming  
2C: 2CH CCT
- 5 P: IP20 Plastic driver

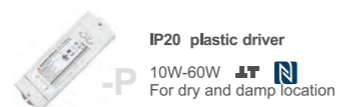

## SMT-M-1C-010CXJ

1 2 3 4 5

- 1 Multi-Current output
- 2 1C: 1CH Dimming  
2C: 2CH CCT
- 3 Power: 10W / 20W / 40W / 60W
- 4 CX: DMX512 Dimming
- 5 J: Aluminum Built-in Junction box driver

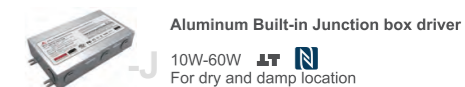

| Power | Picture | Model              | Output            | Input     | Size            | Channels | Address Setting | Location     | Others          |
|-------|---------|--------------------|-------------------|-----------|-----------------|----------|-----------------|--------------|-----------------|
| 60W   |         | SMT-DI060W160-DMXP | 12-54V 160-1600mA | 100-277AC | 342*34.8*24.1mm | 1CH      | NFC             | Dry Damp     | Class P         |
|       |         | SMT-DI060W120-DMXP | 24-93V 120-1200mA | 100-277AC | 342*34.8*24.1mm | 1CH      | NFC             | Dry Damp     | Class P         |
|       |         | SMT-DI060W160-DMXA | 12-54V 160-1600mA | 100-277AC | 332*38.5*23.6mm | 1CH      | NFC             | Wet Dry Damp | Class P TYPE HL |
|       |         | SMT-DI060W120-DMXA | 24-93V 120-1200mA | 100-277AC | 332*38.5*23.6mm | 1CH      | NFC             | Wet Dry Damp | Class P TYPE HL |
|       |         | SMT-DI060W160-DMXI | 12-54V 160-1600mA | 100-277AC | 314*30*21.7mm   | 1CH      | NFC             | Dry Damp     | Class P         |
|       |         | SMT-DI060W120-DMXI | 24-93V 120-1200mA | 100-277AC | 314*30*21.7mm   | 1CH      | NFC             | Dry Damp     | Class P         |
| 60W   |         | SMT-M-xC-060CXJ    | 3-50V 600mA       | 100-277AC | 190*104*36mm    | 1CH      | RDM / NFC       | Dry Damp     | Class 2 Class P |
|       |         | 3-50V 700mA        |                   |           |                 |          |                 |              |                 |
|       |         | 3-50V 800mA        |                   |           |                 |          |                 |              |                 |
|       |         | 3-50V 900mA        |                   |           |                 |          |                 |              |                 |
|       |         | 3-50V 1000mA       |                   |           |                 |          |                 |              |                 |
|       |         | 3-50V 1100mA       |                   |           |                 |          |                 |              |                 |
|       |         | 3-50V 1200mA       |                   |           |                 |          |                 |              |                 |
|       |         | 3-46V 1300mA       |                   |           |                 |          |                 |              |                 |
|       |         | 3-43V 1400mA       |                   |           |                 |          |                 |              |                 |
|       |         | 3-40V 1500mA       |                   |           |                 |          |                 |              |                 |
|       |         | 3-38V 1600mA       |                   |           |                 |          |                 |              |                 |
|       |         | 3-35V 1700mA       |                   |           |                 |          |                 |              |                 |
|       |         | 3-33V 1800mA       |                   |           |                 |          |                 |              |                 |
|       |         | 3-32V 1900mA       |                   |           |                 |          |                 |              |                 |
|       |         | 3-30V 2000mA       |                   |           |                 |          |                 |              |                 |
|       |         | 3-29V 2100mA       |                   |           |                 |          |                 |              |                 |

| Power | Picture | Model              | Output            | Input     | Size              | Channels | Address Setting | Location     | Others          |
|-------|---------|--------------------|-------------------|-----------|-------------------|----------|-----------------|--------------|-----------------|
| 100W  |         | SMT-DI100W210-DMXP | 12-54V 210-2100mA | 100-277AC | 375.8*34.8*24.1mm | 1CH      | NFC             | Dry Damp     | Class P         |
|       |         | SMT-DI100W160-DMXP | 24-93V 160-1600mA | 100-277AC | 375.8*34.8*24.1mm | 1CH      | NFC             | Dry Damp     | Class P         |
|       |         | SMT-DI100W210-DMXA | 12-54V 210-2100mA | 100-277AC | 365.8*38.5*23.6mm | 1CH      | NFC             | Wet Dry Damp | Class P TYPE HL |
|       |         | SMT-DI100W160-DMXA | 24-93V 160-1600mA | 100-277AC | 365.8*38.5*23.6mm | 1CH      | NFC             | Wet Dry Damp | Class P TYPE HL |
|       |         | SMT-DI100W210-DMXI | 12-54V 210-2100mA | 100-277AC | 353*30*21.7mm     | 1CH      | NFC             | Dry Damp     | Class P         |
|       |         | SMT-DI100W160-DMXI | 24-93V 160-1600mA | 100-277AC | 353*30*21.7mm     | 1CH      | NFC             | Dry Damp     | Class P         |